



**ROLLER SHADES**  
**FASCIA SYSTEMS**

Installation Manual v2.1



#cbmblinds



**CBM**

### Hazardous Product Warning (Manual/Chain Driven Shades)



## WARNING/MISE EN GARDE

Young children can **STRANGLE** in cord and bead chain loops. They can also wrap cords around their necks and **STRANGLE**. Always keep cords and bead chains out of children's reach.

Move cribs, playpens, and other furniture away from cords and bead chains. Children can climb furniture to get to cords.

Attach tension device to wall or to floor. This can prevent children from pulling cords and bead chains around their necks. Fasteners provided with the tension device may not be suitable for all mounting surfaces. Use appropriate anchors for the mounting surface conditions.

For more safety information: 1-866-662-0666

### 3" Fascia Assembly Parts:

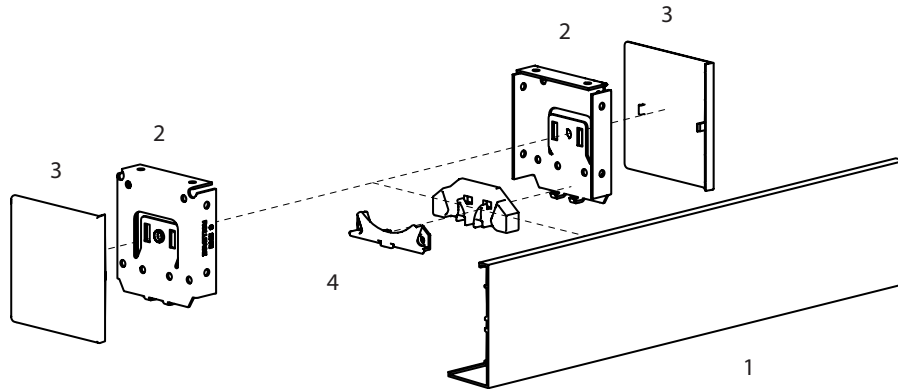

1. 3" Fascia Cover
2. Fascia Installation Brackets
3. Fascia Bracket Covers
4. Chain Guide

### Parts Included:



Installation Screws

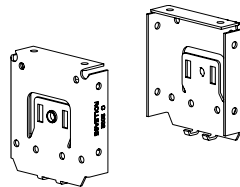

3" Fascia Brackets



Chain Guide & Cover (Small clutch)  
Chain Guide Only (Large Clutch)

### Tools Needed:



Pencil

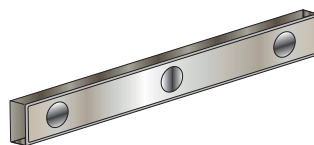

Level

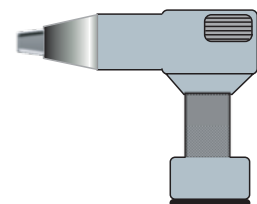

Cordless Drill

### 3" Fascia Bracket Installation:

Brackets are universal and can be installed in any orientation shown below:

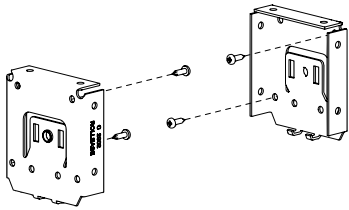

Inside Mount

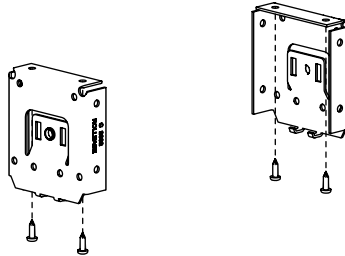

Ceiling Mount

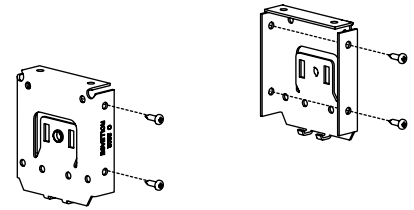

Wall Mount

### 3" Fascia Shade Installation:

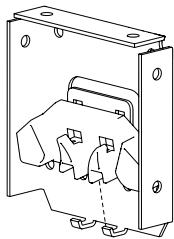

Attach chain diverter on the control side bracket

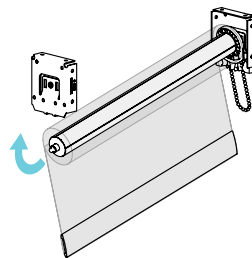

Align clutch end first, swing shade assembly to the pin end bracket as shown

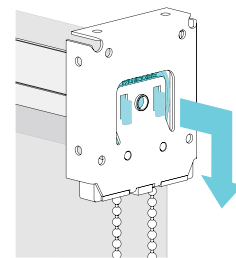

Ensure clutch hooks are engaged

### 3" Fascia Cover Installation:

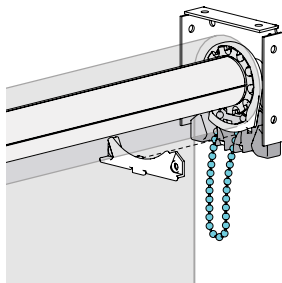

Attach chain diverter cover (small clutch only) and ensure that chain is properly aligned

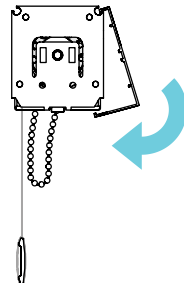

Attach fascia cover, swing from the top as shown above

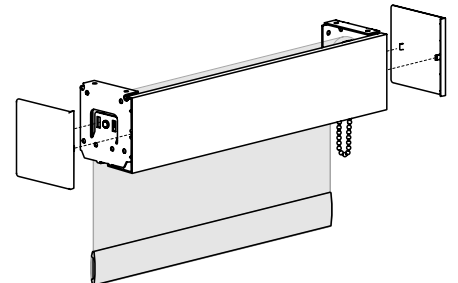

Attach bracket covers if needed (outside mt)

### Tension Device Installation:

Tension device is pre-assembled onto chain during fabrication/production and must be installed for the shade to function properly.

Recess Fix



Wall/Face Fix

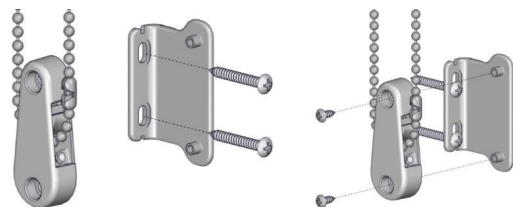

### Hazardous Product Warning (Manual/Chain Driven Shades)



## WARNING/MISE EN GARDE

Young children can **STRANGLE** in cord and bead chain loops. They can also wrap cords around their necks and **STRANGLE**.

Always keep cords and bead chains out of children's reach.

Move cribs, playpens, and other furniture away from cords and bead chains. Children can climb furniture to get to cords.

Attach tension device to wall or to floor. This can prevent children from pulling cords and bead chains around their necks. Fasteners provided with the tension device may not be suitable for all mounting surfaces. Use appropriate anchors for the mounting surface conditions.

For more safety information: 1-866-662-0666

### 4" Fascia Assembly Parts:

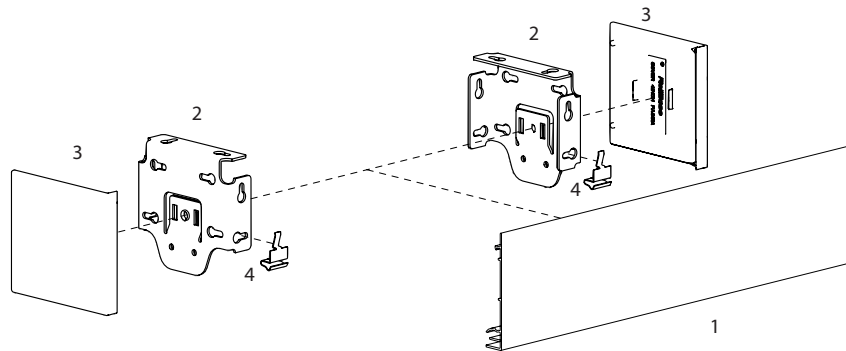

1. 4" Fascia Cover
2. Fascia Installation Brackets
3. Fascia Bracket Covers
4. Fascia Bracket Clip

### Parts Included:



Installation Screws

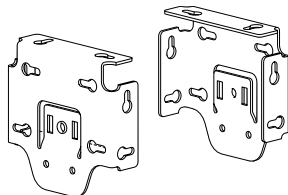

4" Fascia Brackets



4" Fascia Clips (1 per bracket)

### Tools Needed:



Pencil

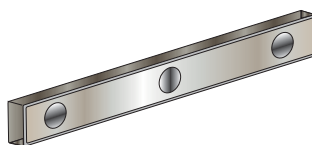

Level

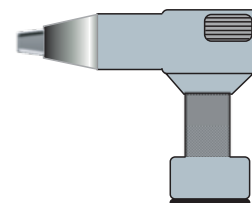

Cordless Drill

### 4" Fascia Bracket Installation:

Brackets are universal and can be installed in any orientation shown below:

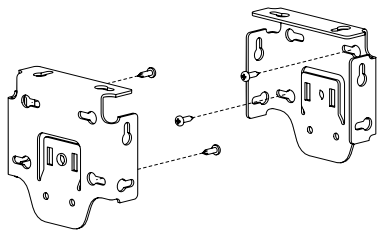

Inside Mount

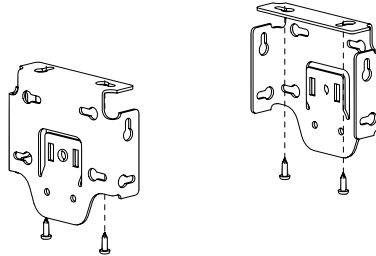

Ceiling Mount

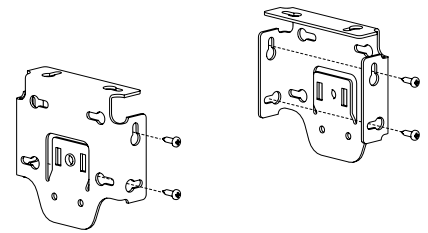

Wall Mount

### 4" Fascia Shade Installation:

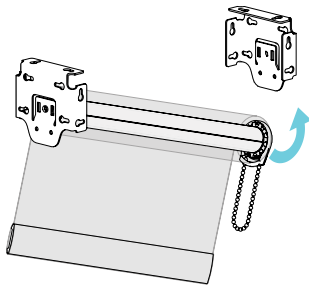

Compress idler and swing shade assembly to the bracket

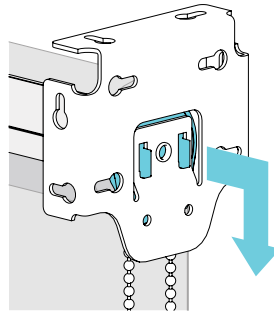

Ensure clutch hooks are engaged

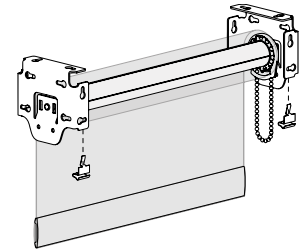

Attach fascia clip

### 4" Fascia Cover Installation:

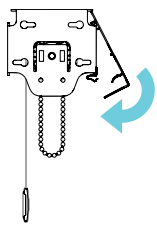

Attach fascia cover, hook the top and then swing bottom

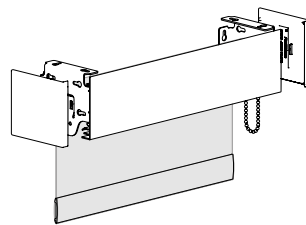

Attached bracket covers if needed (outside mt)

### Tension Device Installation:

Tension device is pre-assembled onto chain during fabrication/production and must be installed for the shade to function properly.



Recess Fix



Wall/Face Fix

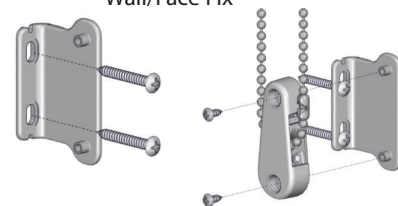

Please operate the chain with caution. Unrolling the shade past its window frame can cause permanent damage to the shade.